

---

USER MANUAL

# PowerValue 11 RT G2

## 6-10 kVA









# About this manual

## Document information

<b>File name</b>	:	04-3788_ABB_OPM_PVA11 6-10kVA-RT_G2_EN_REV-C
<b>UPS model</b>	:	PowerValue 11 RT G2 6-10 kVA
<b>Date of issue</b>	:	06.04.2018
<b>Issued by</b>	:	Product Marketing
<b>Checked by</b>	:	R&D After Sales
<b>Article number</b>	:	04-3788
<b>Document number</b>	:	4NWD003231
<b>Revision</b>	:	C

## Safety symbols and warnings

The following symbols are used in this manual, the list below explains each symbol.

	This symbol in conjunction with the signal word "DANGER" indicates an imminent electrical hazard. Failure to observe the related safety note may cause injury, death or equipment damage.
	This symbol in conjunction with the signal word "WARNING" indicates a potentially dangerous situation. Failure to observe may cause injury, death or equipment damage.
	This symbol in conjunction with the signal word "NOTE" indicates operator tips or particularly useful or important information for the use of the product. This symbol and wording does not indicate a dangerous situation.
	This symbol indicates that reading the instruction manual/booklet before starting work or before operating equipment or machinery is compulsory.
	Recycle.
	Do not dispose of with ordinary trash.

# Contents

<b>1</b>	<b>Important safety instructions</b>	<b>5</b>
1.1	Operator precautions	5
1.2	Environmental considerations	5
1.3	Declaration of safety conformity and CE marking	6
1.4	Inquiries	6
1.5	Operation	7
<b>2</b>	<b>Maintenance</b>	<b>8</b>
<b>3</b>	<b>Installation</b>	<b>9</b>
3.1	<b>Delivery, transportation, positioning and storage</b>	<b>9</b>
3.1.1	Receipt of the UPS and visual inspection	9
3.1.2	Unpacking list	9
3.1.3	Storage of UPS	9
3.2	<b>Site planning and positioning</b>	<b>10</b>
3.2.1	Planning before the installation	10
3.2.2	Positioning	10
3.2.3	Rack mount installation	10
3.2.4	Standalone / tower installation	11
3.3	<b>General characteristics</b>	<b>13</b>
3.3.1	UPS front panel	13
3.3.2	UPS rear panel	13
3.4	<b>Electrical installation</b>	<b>15</b>
3.4.1	Commissioning	15
3.4.2	Recommended cable sections and fuse ratings	15
3.4.3	Connections	16
3.4.4	PDU terminal block access (optional)	16
3.4.5	Parallel installation operation	17
<b>4</b>	<b>Operation</b>	<b>20</b>
4.1	<b>Control panel</b>	<b>20</b>
4.1.1	Selection keys	20
4.1.2	LED's status indicators	20
4.1.3	LCD	21
4.2	<b>Operating mode</b>	<b>22</b>
4.3	<b>UPS start-up and shutdown</b>	<b>23</b>
4.3.1	UPS start-up	23
4.3.2	UPS shutdown	23
4.4	<b>Display functions</b>	<b>24</b>
4.5	<b>User settings</b>	<b>25</b>
4.6	<b>LCD operation</b>	<b>26</b>
4.6.1	Main menu	26
4.6.2	UPS status menu	26
4.6.3	Measurement menu	27
4.6.4	Event log menu	27
4.6.5	Control menu	28
4.6.6	Identification menu	28
4.6.7	Setting menu	29

<b>5</b>	<b>Communication</b> . . . . .	<b>30</b>
5.1	RS-232 port . . . . .	30
5.2	USB port . . . . .	31
5.3	Emergency power off . . . . .	31
5.3.1	Dry IN . . . . .	31
5.3.2	Dry OUT . . . . .	31
5.4	Network management card (optional) . . . . .	32
5.4.1	Installing a serial network management card (optional) . . . . .	32
5.4.2	Monitoring software . . . . .	32
<b>6</b>	<b>Troubleshooting</b> . . . . .	<b>33</b>
6.1	Fault identification and rectification . . . . .	33
6.2	Accessing alarms . . . . .	33
6.3	Silencing the alarm . . . . .	36
	<b>Appendix A</b> . . . . .	<b>37</b>
	<b>Appendix B</b> . . . . .	<b>38</b>

# 1 Important safety instructions



READ THIS IMPORTANT SAFETY INSTRUCTION CHAPTER BEFORE READING THE OPERATING MANUAL

## 1.1 Operator precautions

Always follow the precautions and instructions described in this manual. Any deviations from the instructions may result in electric shock or cause accidental load loss.

**ABB DOES NOT TAKE ANY RESPONSIBILITY FOR DAMAGES CAUSED THROUGH INCORRECT USE OF THE UPS SYSTEM.**



DANGER

DO NOT REMOVE ANY SCREWS FROM THE UPS SYSTEM OR FROM THE BATTERY CABINET: DANGER OF ELECTRICAL SHOCK.



DANGER

HIGH FAULT CURRENTS (LEAKAGE CURRENTS). BEFORE CONNECTING THE MAINS ENSURE THAT THE UPS IS EARTHED!



DANGER

DISPLAY A WARNING LABEL ON ALL PRIMARY POWER ISOLATORS INSTALLED AWAY FROM THE UPS AREA TO WARN ELECTRICAL MAINTENANCE PERSONNEL THAT THE CIRCUIT FEEDS A UPS.

MAKE SURE THAT WARNING LABEL CONTAINS THE FOLLOWING TEXT OR EQUIVALENT: "ISOLATE THE UPS (UNINTERRUPTIBLE POWER SUPPLY) BEFORE WORKING ON THIS CIRCUIT."

## 1.2 Environmental considerations

To operate the UPS with optimal efficiency, your installation site should meet the environmental parameters outlined in this user manual. Excessive amounts of dust or moisture in the operating environment may cause damage or lead to malfunction. The UPS should always be protected from the weather and sunshine. The operating environment must meet the weight, airflow, size and clearance requirements specified in the technical datasheet.

Under no circumstances should the UPS be installed in an airtight room, in the presence of flammable gases, or in an environment exceeding the environmental requirements specified below. An ambient temperature of +20°C to +25°C is recommended to achieve a long life of the UPS and batteries. The cooling air entering the UPS must not exceed +40 °C and the humidity should be below 95 percent (non-condensing).

## 1.3 Declaration of safety conformity and CE marking

The **PowerValue 11 RT G2 6-10 kVA** is designed, manufactured and commercialized in accordance with the **EN ISO 9001** standard relating to quality management systems.

These products conform with the following directives:

- 2014/35/EU Low voltage directive
- 2014/30/EU Electromagnetic Compatibility directive (EMC)
- 2011/65/EU Restriction of the use of certain hazardous substances (RoHS) directive

These products also meet the following product standards:

**Table 1: Standards**

	Product Standards
Safety	IEC/EN 62040-1:2008+A1:2013
EMC	IEC/EN 62040-2:2006
Performance	IEC/EN 62040-3
ESD	IEC 61000-4-2: Level 3
Radiated field	IEC 61000-4-3: Level 3
EFT	IEC 61000-4-4: Level 4
Fast transients	IEC 61000-4-5: Level 4
Electromagnetic field	IEC 61000-4-6: Level 3
Conducted magnetic field	IEC 61000-4-8: Level 4
RoHS	IEC/EN50581:2012

## 1.4 Inquiries

Inquiries regarding the UPS should be addressed to the local ABB office or agent authorized by ABB. Note the type code and the serial number of the equipment before

contacting ABB or authorized agent. The serial number is shown on the nameplate of the product. For further information on troubleshooting, see Chapter 6.

## 1.5 Operation



WARNING

DO NOT DISCONNECT THE MAINS CABLE FROM THE UPS OR THE BUILDING WIRING SOCKET DURING OPERATION AS THIS REMOVES THE GROUND FROM THE UPS AND ALL CONNECTED LOADS.



NOTE

PRESS THE OFF BUTTON TO FULLY DISCONNECT THE UPS. ENSURE THE UPS IS ON BYPASS OR ON STANDBY MODE BEFORE DISCONNECTING IT FROM THE MAINS.



TO REDUCE THE RISK OF FIRE, CONNECT THE UPS TO A CIRCUIT PROVIDED WITH BRANCH CIRCUIT OVERCURRENT PROTECTION WITH AN AMPERE RATING IN ACCORDANCE WITH THE IEC/EN 60934 STANDARD OR YOUR LOCAL ELECTRICAL CODE.



NOTE

SEE TECHNICAL SPECIFICATIONS FOR RECOMMENDATIONS.



WARNING

INDISCRIMINATE OPERATION OF SWITCHES MAY CAUSE OUTPUT LOSS OR DAMAGE TO EQUIPMENT.



WARNING

NEVER DISPOSE OF BATTERIES IN A FIRE AS THEY MAY EXPLODE.



WARNING

DO NOT OPEN OR DAMAGE THE BATTERIES.



WARNING

RELEASED ELECTROLYTE IS HARMFUL TO THE SKIN AND EYES.

## 2 Maintenance

**PowerValue 11 RT G2 6-10 kVA UPS** requires only minimal maintenance.

Charge the UPS regularly to maximize the expected life of the battery. When connected to mains power, the UPS charges the batteries and prevents the batteries from overcharging and over-discharging.

- Replace the batteries when the battery service life has been exceeded (around three to five years at 25°C ambient temperature). Contact your local ABB or an agent authorized by ABB for replacements.
- Charge the UPS once every four to six months if it is not used regularly.
- In high-temperature regions, charge and discharge the battery every two months. The standard charging time should be at least 12 hours.
- Replace the battery when the discharge time is less than 50 percent of specified after fully charging. Check the battery connection or contact your local dealer to order a new battery.



DANGER

COMPONENTS INSIDE THE UPS ARE CONNECTED TO THE BATTERY EVEN WHEN THE UPS IS DISCONNECTED FROM THE MAINS POWER SUPPLY.



DANGER

DISCONNECT THE BATTERIES BEFORE CARRYING OUT ANY KIND OF SERVICE AND/OR MAINTENANCE. VERIFY THAT NO CURRENT IS PRESENT, AND NO HAZARDOUS VOLTAGE EXISTS IN THE CAPACITOR OR BUS CAPACITOR TERMINALS.



DANGER

THE BATTERY CIRCUIT IS NOT ISOLATED FROM THE INPUT VOLTAGE. HAZARDOUS VOLTAGES MAY OCCUR BETWEEN THE BATTERY TERMINALS AND THE GROUND. VERIFY THAT NO VOLTAGE IS PRESENT BEFORE SERVICING.



DANGER

A BATTERY CAN PRESENT A RISK OF ELECTRICAL SHOCK AND HIGH SHORT CIRCUIT CURRENT. THE FOLLOWING PRECAUTIONS SHOULD BE OBSERVED WHEN WORKING ON BATTERIES:

- REMOVE WATCHES, RINGS OR OTHER METAL OBJECTS
- MAKE USE OF PROPER PPE (PERSONAL PROTECTION EQUIPMENT) AS PER LOCAL POLICIES AND RULES
  - WEAR FLAME/ARC RESISTANT WHOLE BODY CLOTHING
  - WEAR SUITABLE VOLTAGE RATED GLOVES
  - USE SAFETY DIELECTRIC FOOTWEAR
  - WEAR ARC FLASH FACE SHIELD
  - USE VOLTAGE RATED TOOLS
- DO NOT LAY TOOLS OR METAL PARTS ON TOP OF BATTERIES
- DISCONNECT THE CHARGING SOURCE PRIOR TO CONNECTING OR DISCONNECTING BATTERY TERMINALS.



WARNING

REPLACE BATTERIES WITH THE SAME NUMBER AND SAME TYPE OF BATTERIES.



WARNING

REPLACE FUSES ONLY WITH FUSES OF THE SAME TYPE AND OF THE SAME AMPERAGE TO AVOID FIRE HAZARDS.

## 2.1 UPS disposal and recycling

### 2.1.1 For professional users in the European Union

---

THE CROSSED-OUT WHEELED BIN SYMBOL ON THE PRODUCT(S) AND / OR ACCOMPANYING DOCUMENTS MEANS THAT USED ELECTRICAL AND ELECTRONIC EQUIPMENT (WEEE) SHOULD NOT BE MIXED WITH GENERAL HOUSEHOLD WASTE.



IF YOU WISH TO DISCARD ELECTRICAL AND ELECTRONIC EQUIPMENT (EEE), PLEASE CONTACT YOUR DEALER OR SUPPLIER FOR FURTHER INFORMATION.

DISPOSING OF THIS PRODUCT CORRECTLY WILL HELP SAVE VALUABLE RESOURCES AND PREVENT ANY POTENTIAL NEGATIVE EFFECTS ON HUMAN HEALTH AND THE ENVIRONMENT, WHICH COULD OTHERWISE ARISE FROM INAPPROPRIATE WASTE HANDLING.

---

### 2.1.2 For disposal in countries outside of the European Union

---

THE CROSSED-OUT WHEELED BIN SYMBOL IS ONLY VALID IN THE EUROPEAN UNION (EU) AND MEANS THAT USED ELECTRICAL AND ELECTRONIC EQUIPMENT (WEEE) SHOULD NOT BE MIXED WITH GENERAL HOUSEHOLD WASTE.



IF YOU WISH TO DISCARD THIS PRODUCT PLEASE CONTACT YOUR LOCAL AUTHORITIES OR DEALER AND ASK FOR THE CORRECT METHOD OF DISPOSAL.

DISPOSING OF THIS PRODUCT CORRECTLY WILL HELP SAVE VALUABLE RESOURCES AND PREVENT ANY POTENTIAL NEGATIVE EFFECTS ON HUMAN HEALTH AND THE ENVIRONMENT, WHICH COULD OTHERWISE ARISE FROM INAPPROPRIATE WASTE HANDLING.

---



# 3 Installation

## 3.1 Delivery, transportation, positioning and storage

### 3.1.1 Receipt of the UPS and visual inspection

When receiving the UPS, carefully examine the packing container and the UPS for any signs of physical damage. In case of damage, notify the carrier immediately.

The packing container of the UPS protects it from mechanical and environmental damage. To increase protection, the UPS is wrapped in a plastic sheet. Keep the packaging for later re-use.

### 3.1.2 Unpacking list

After examining the package, open the box and check the following items are included:

- 1 x PowerValue 11 RT G2 UPS
- 1 x user manual
- 2 x UPS stands (support)
- 4 x M4 round screw (UPS stands)
- EPO contactor
- Dry contactor
- 1 x IEC C13-C14 cable
- 1 x monitoring software CD
- 1 x 15-pin communication cable (for parallel systems)
- RS232 cable
- 1 x USB cable

Rack-mounting accessories (full rack-mounting kit can be purchased separately):

- 2 x 90° rack mounting brackets
- 4 x M6 clip nuts
- 12 x M6 screws
- 4 x M4 screws

Examine the UPS for any signs of damage and ensure that the received UPS corresponds to the material indicated in the delivery note. Notify your carrier or supplier immediately in case of any damage.

### 3.1.3 Storage of UPS

If you plan to store the UPS prior to use, keep it in a dry, clean and cool storage room with an ambient temperature between -15 °C to +60°C and humidity of less than 95 percent (non-condensing). If the packing container has been removed, protect the UPS from dust. Always keep the UPS in an upright position and do not drop.

## 3.2 Site planning and positioning

- 01 Ear bracket
- 02 Rack rails
- 03 Rack mount installation

### 3.2.1 Planning before the installation

To ensure a long service life, install the unit in a position where any danger to the UPS is minimized:

- Install the UPS indoors.
- Leave 50 cm of space on each side of the cabinet to allow cooling airflow and ensure that the circulation of air to the ventilation slits is not obstructed.
- Avoid excessively high temperatures and excessive moisture.
- Make sure that the surface is solid and flat.

### 3.2.2 Positioning

PowerValue 11 RT G2 can be mounted in a rack or installed in a standalone configuration.



WARNING

WATER CONDENSATION MAY OCCUR IF THE UPS IS UNPACKED IN A VERY LOW TEMPERATURE. TO AVOID HAZARDS AND RISK OF ELECTRIC SHOCK, WAIT UNTIL THE UPS IS FULLY DRY BOTH INSIDE AND OUTSIDE BEFORE INSTALLING/USING THE UPS.

### 3.2.3 Rack mount installation

#### 3.2.3.1 UPS

Note that you need a rack-mounting kit (purchased separately) for this operation. This procedure is suitable for 19-inch rack cabinet installation with a maximum depth of 800 mm.

Identify the final position and keep 2U spacing for this installation.

1. Install the ear bracket onto the unit using the M4 flathead screws (figure 1).
2. Slide the unit into the rail kit and make sure to tighten the rack-mounting screw (figure 3).

If installing additional UPS units, repeat the steps above for each cabinet.

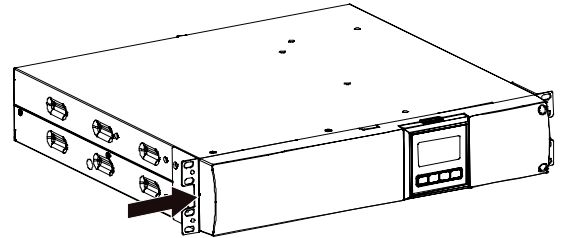

01

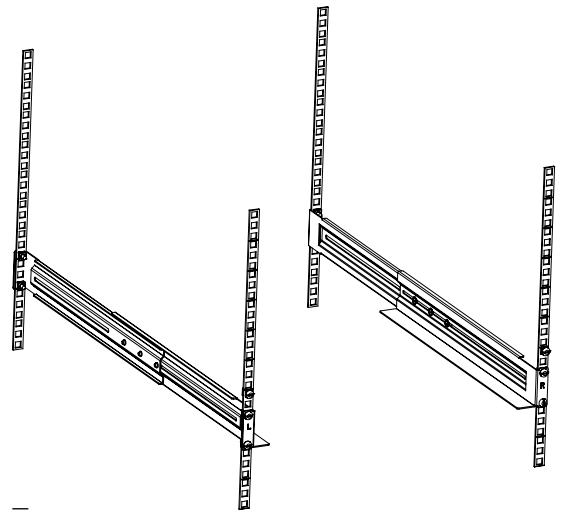

02

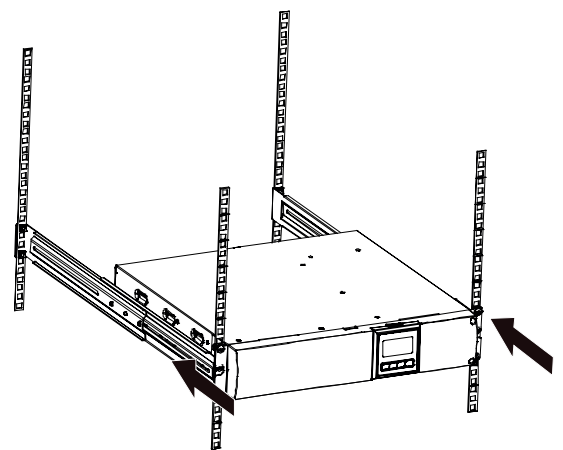

03

- 04 Battery module connection
- 05 Display rotation
- 06 Stabilizer bracket for external batter module

**3.2.3.2 External battery modules**

Identify the final position and keep 3U spacing for this installation; it is recommended that this spacing is provided below the UPS.

1. Install the ear bracket onto the unit with the flathead M4 screw. (figure 1).
2. Slide the unit into the rail kit and make sure to tighten the rack-mounting screw (figure 3).
3. Connect the EBM to the UPS with the battery power cable (figure 4).

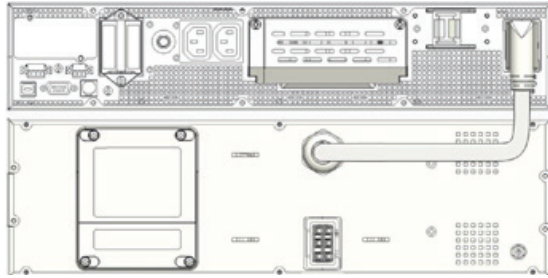

04



NOTE

UP TO FOUR EXTERNAL BATTERY ENCLOSURES CAN BE CONNECTED TO THE UPS IN THE SAME WAY AS SHOWN ABOVE.



NOTE

AFTER CONNECTING THE BATTERY ENCLOSURES, CONFIGURE THE NUMBER OF BATTERY MODULES IN THE CONTROL PANEL (FOR MORE INFORMATION SEE CHAPTER 4.6.7). SEE APPENDIX C FOR FURTHER DETAILS.

**3.2.4 Standalone / tower installation**

**3.2.4.1 UPS**

1. Rotate the LCD module to tower direction. (figure 5).

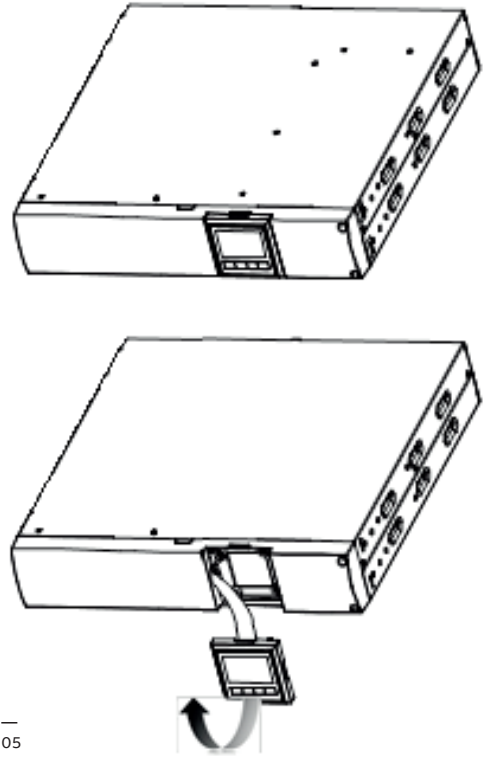

05

2. Set up the stabilizer bracket then put the unit into the stabilizer bracket.

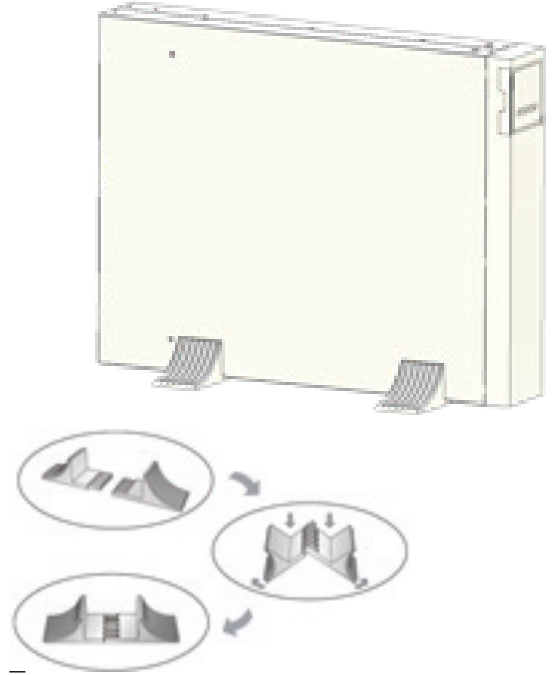

06

—  
7 Stabilizer bracket for  
external batter module

### 3.2.4.2 External battery modules

1. Set up the extension plate as below and install it on the UPS stabilizer bracket.
2. Install the UPS and EBM individually into the stabilizer bracket.
3. Connect to the UPS with the battery power cable (refer to rack position installation).

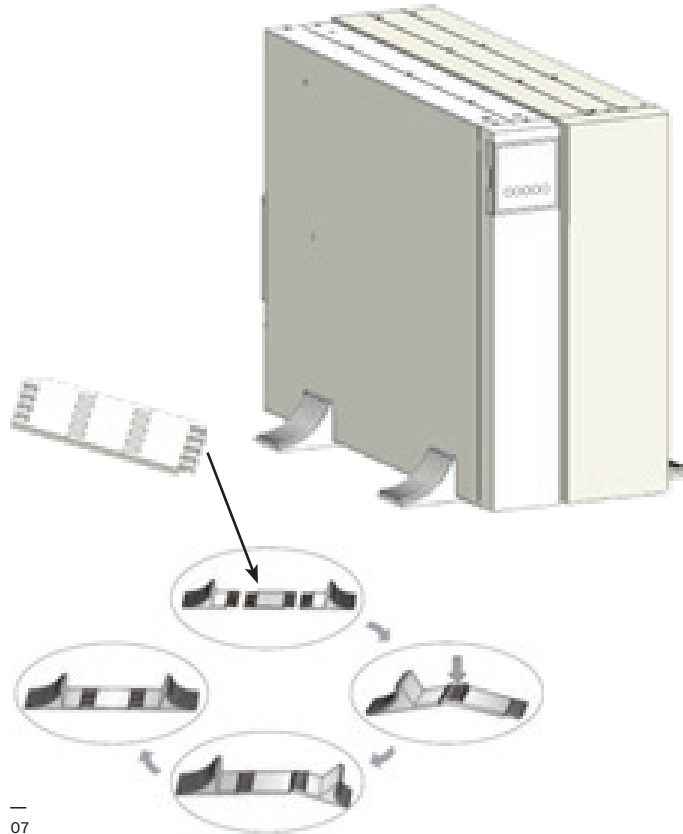

—  
07

**Note:**

It is recommended that this unit be installed to UPS's righthand side.

If installing an additional unit, place it next to the previous unit.

## 3.3 General characteristics

- 08 UPS front panel
- 09 UPS rear view

### 3.3.1 UPS front panel

Figure 8 shows the front panel of the UPS.

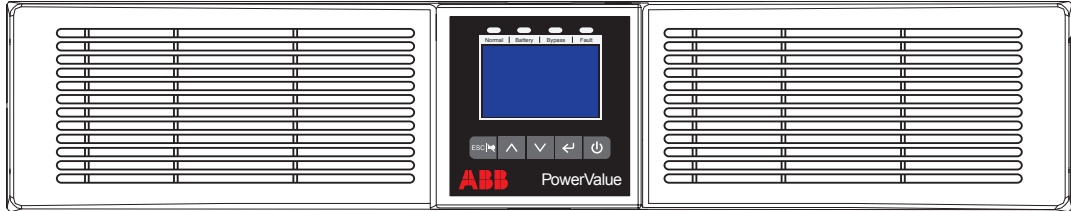

08

### 3.3.2 UPS rear panel

Table 2 and Figures 9, and Table 3 and Figure 10 show the connectors and ports in the UPS and external battery module rear panel.

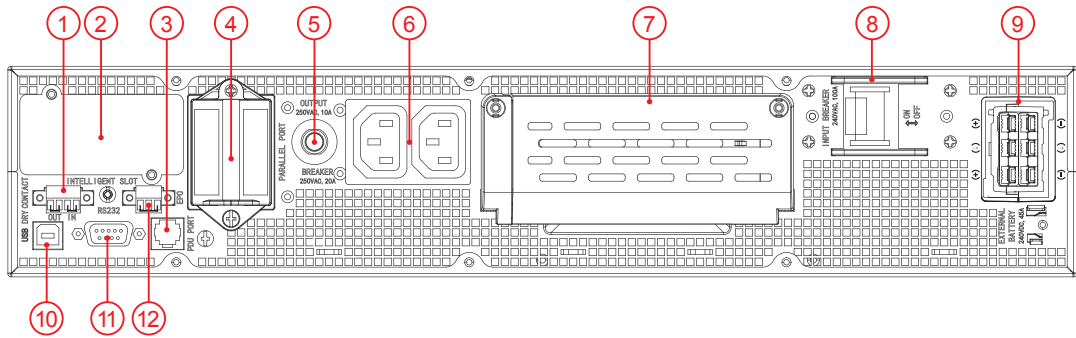

09

**Table 2: UPS rear panel connectors and ports**

1	Dry IN/OUT
2	SNMP/ AS400 slot
3	RJ11 (PDU connection)
4	Parallel card
5	Output breaker
6	Output socket
7	Input/Output terminals
8	Input breaker
9	EBM connector
10	USB
11	RS232
12	EPO

10 External battery module rear view

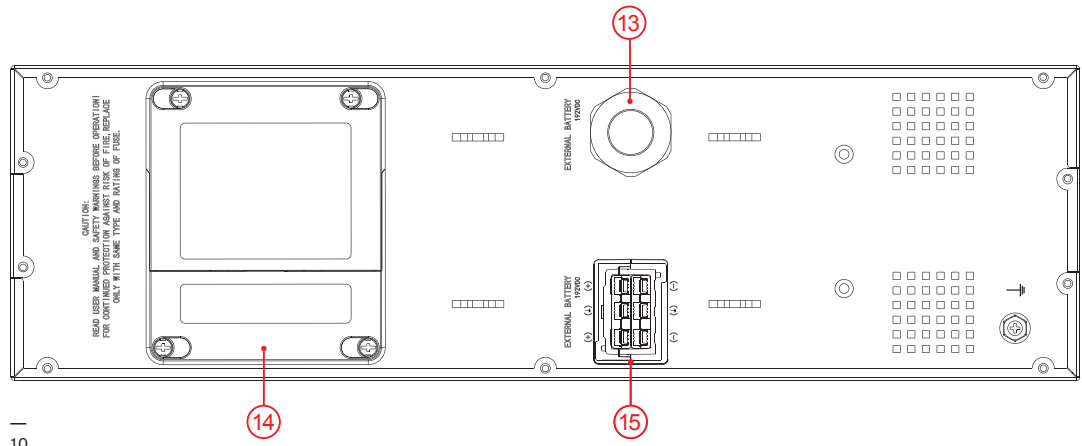

Table 3: External battery module rear panel connectors and ports

13	EBM terminal
14	Fuse board cover (to replace EBM fuse)
15	EBM connector

# 3.4 Electrical installation

- 11 Circuit breaker
- 12 External back-feed isolation

## 3.4.1 Commissioning

The commissioning of the UPS includes the connection of the UPS and batteries, the verification of the electrical installation and operating environment of the UPS, the controlled start-up and testing of the UPS, and customer training.



WARNING

DO NOT OPERATE IN CASE OF PRESENCE OF WATER OR MOISTURE.



DANGER

WHEN OPENING OR REMOVING THE UPS COVERS YOU ARE EXPOSED TO DANGEROUS VOLTAGES.

## 3.4.2 Recommended cable sections and fuse ratings

When selecting the cable cross-sections and the protective devices, follow the recommendations in the technical specifications document or follow local standards.



DANGER

TO REDUCE THE RISK OF FIRE, THE UNIT SHOULD ONLY CONNECT TO A CIRCUIT PROVIDED WITH BRANCH CIRCUIT OVERCURRENT PROTECTION FOR:

- D CURVE 63 A RATING (UPSTREAM CIRCUIT), FOR 6KVA MODELS,
- D CURVE 80 A RATING (UPSTREAM CIRCUIT), FOR 10KVA MODELS

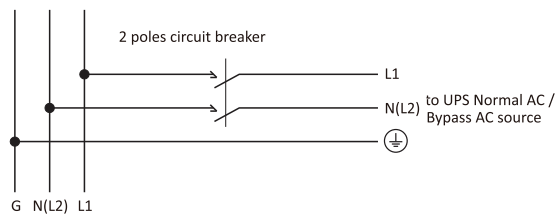

11

Table 4: Recommended cable cross sections

Model	6K	10K
Protective earthing conductor (min. cross section)	10 mm <sup>2</sup> (8 AWG)	16 mm <sup>2</sup> (6 AWG)
Input L, N, G (min conductor cross section)	10 mm <sup>2</sup> (8 AWG)	16 mm <sup>2</sup> (6 AWG)
Input fuse	63 A	80 A
Output L,N, (min. conductor cross section)	10 mm <sup>2</sup> (8 AWG)	16 mm <sup>2</sup> (6 AWG)



DANGER

RISK OF BACKFEED VOLTAGE. ISOLATE THE UPS BY INSTALLING AN EXTERNAL ISOLATING DEVICE BETWEEN THE MAINS INPUT AND THE UPS.

BEFORE WORKING ON THIS CIRCUIT, CHECK FOR HAZARDOUS VOLTAGE.

ABB recommends that an external isolating device is installed between the mains input and UPS as shown in Figure 12 to protect against backfeed currents.

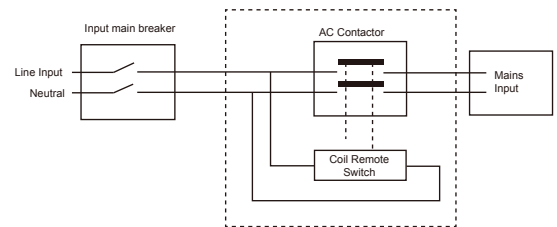

- AC Contactor: 208-240 V, 63 A (PowerValue 11 RT G2 6 kVA)
- 208-240 V, 80 A (PowerValue 11 RT G2 10 kVA)

12

- 13 Terminal block cover
- 14 Terminal connections
- 15 PDU terminal block access

### 3.4.3 Connections



DANGER

HIGH LEAKAGE CURRENT: MAKE SURE THAT THE EARTH WIRE IS CONNECTED. COMMON INPUT/OUTPUT SOURCES CONNECTION



WARNING

BEFORE CARRING OUT ANY CONNECTION, CHECK THAT THE UPSTREAM PROTECTION DEVICES (NORMAL AC SOURCE AND BYPASS AC SOURCES) ARE OPEN "0" (OFF).

To access the terminal blocks, remove the terminal block cover by unscrewing the two screws as shown in Figures 13.

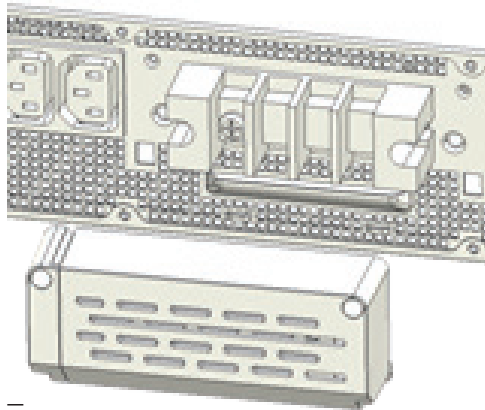

13

Connect the AC cable to the terminal blocks; refer to the indication on the rear panel.

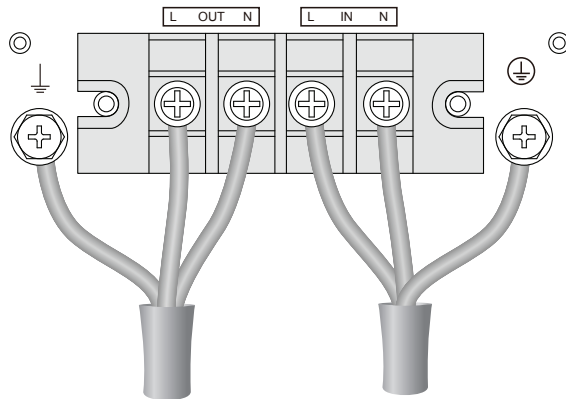

14

Tie up the AC cable to the rear panel and re-install the cover of the terminal block.



WARNING

INDUCTIVE LOADS (FOR EXAMPLE MONITORS AND LASER PRINTERS) HAVE A VERY HIGH POWER CONSUMPTION AT START-UP. IF CONNECTED TO THE UPS, THE START-UP POWER OF SUCH LOADS MUST BE TAKEN INTO CONSIDERATION WHEN CALCULATING THE CAPACITY OF THE UPS TO PREVENT THE UPS FROM BEING OVERLOADED AND TURNED OFF.

### 3.4.4 PDU terminal block access (optional)

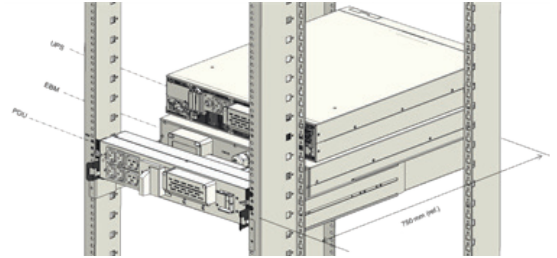

15

If you ordered the PDU model, please connect the UPS's terminal blocks from PDU's source. For detailed operation, please refer to PDU's user manual.



16 Parallel system installation diagram

**3.4.5 Parallel installation operation**

Up to three UPSs can be connected in parallel to configure a sharing and redundant output power.

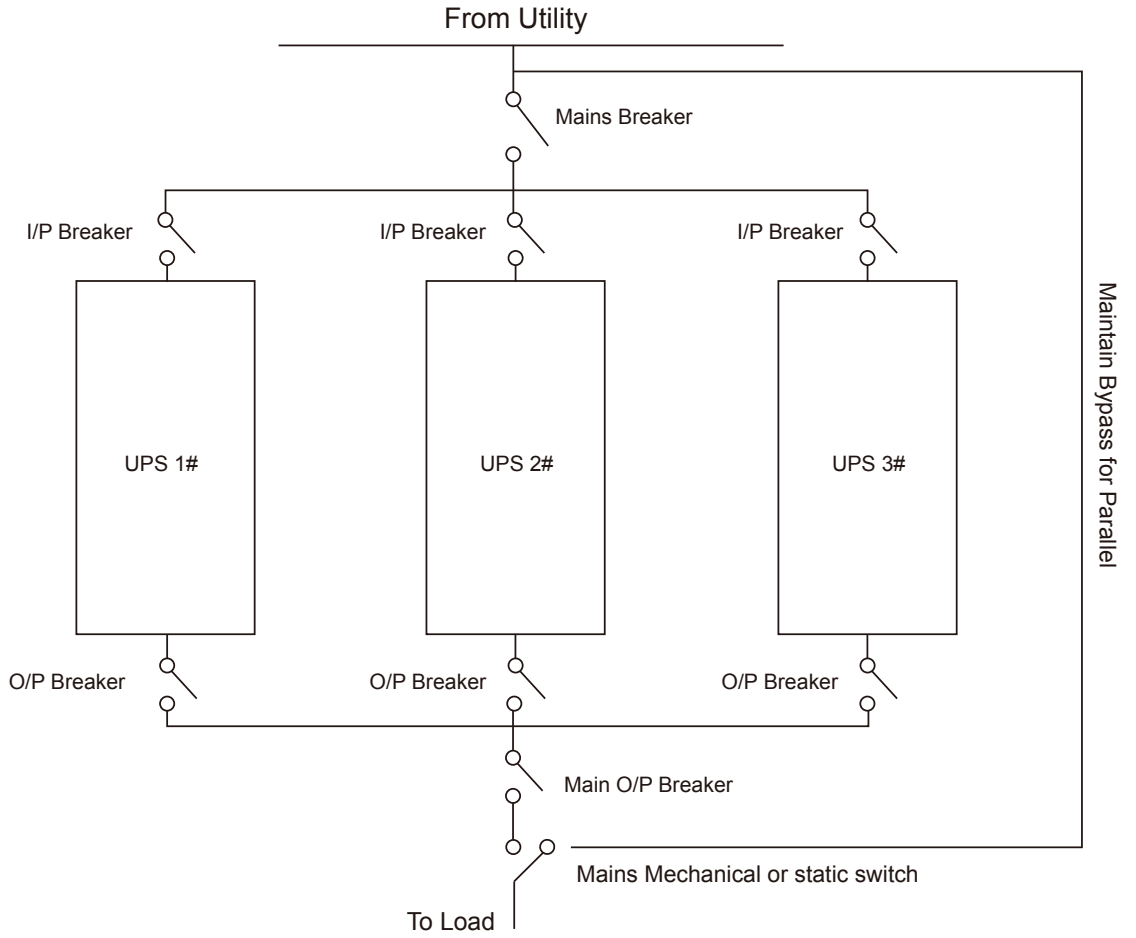

- 17 Parallel cable connection
- 18 Parallel connection cable locker
- 19 Parallel system wiring diagram

**How to install a new parallel UPS system:**

1. Before installing a new parallel UPS system, prepare the input/output wires, breakers and a main maintenance mechanical switch or static switch.
2. Independent battery packs for each UPS.
3. Remove the cover plate from the parallel connection port on the UPS, connect each UPS one by one with a parallel connection cable and make sure the cable is screwed in tightly.

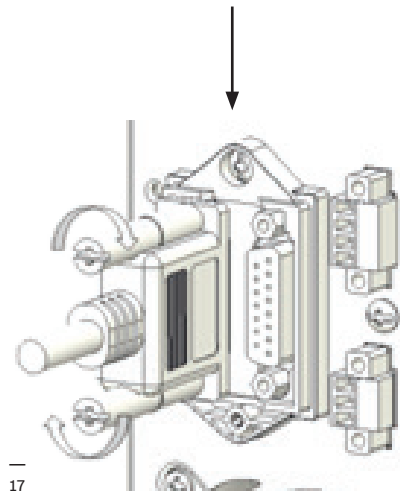
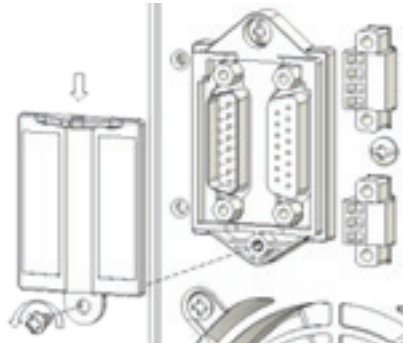

17

4. Install the cable locker to protect the parallel cable for each UPS.

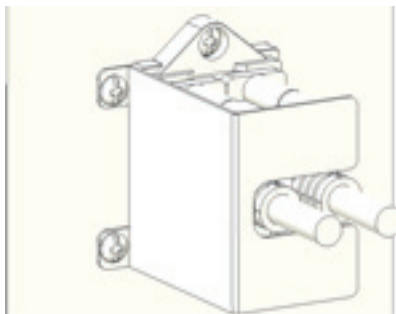

18

5. Connect the input and output wires and make sure all the breakers are turned off.

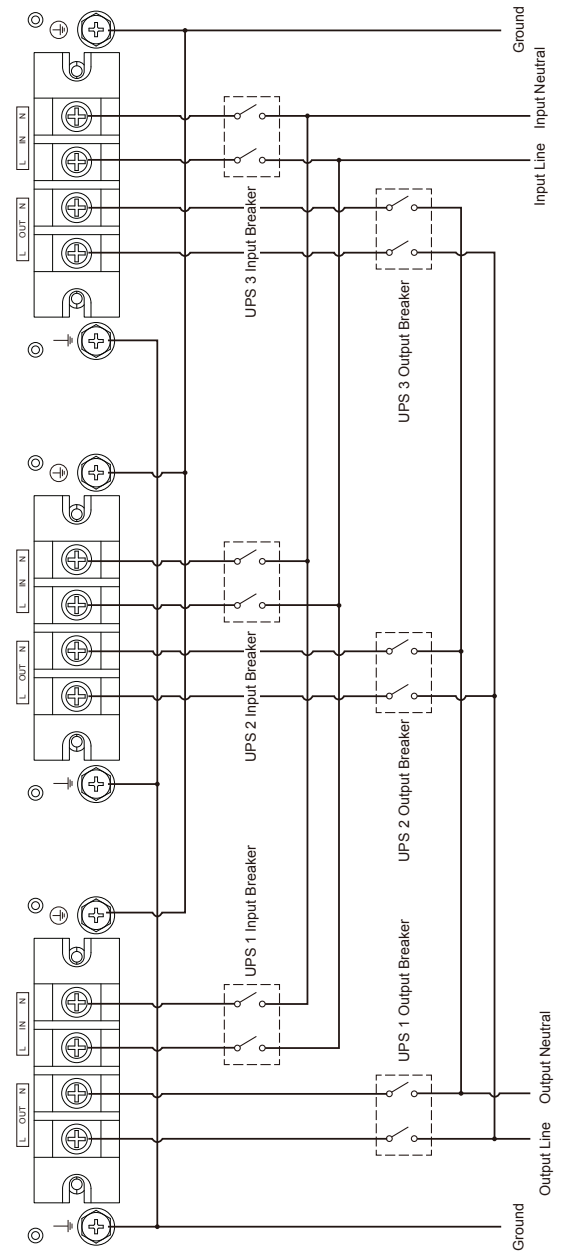

19

6. Turn on the input breakers for the parallel UPS.
7. Hold button for more than 1 s on one UPS in the system; the system will then switch to line mode.
8. Check the output voltage of each UPS separately and check if the difference in output voltage is less than 0.5 V among the units in the parallel system. If the difference is more than 0.5 V, the UPS need to be regulated.
9. If the difference in output voltage is less than 0.5 V, turn off the input breakers to let the UPS shut down. Then switch on the output breakers for all UPSs.
10. Switch on the input breakers for the parallel UPS. Hold button for more than 1 s on one UPS in the system; the system will then switch to line mode. After these operations, the system will work normally in parallel mode.

---

WIRING REQUIREMENT:



1. IF THE DISTANCE BETWEEN THE UPS AND BREAKER PANEL IS LESS THAN 20 METERS IN A PARALLEL SYSTEM, THE LENGTH DIFFERENCE BETWEEN INPUT AND OUTPUT CABLE OF THE UPS IS REQUIRED TO BE LESS THAN 20%.
  2. IF THE DISTANCE BETWEEN THE UPS AND BREAKER PANEL IS MORE THAN 20 METERS IN A PARALLEL SYSTEM, THE LENGTH DIFFERENCE BETWEEN INPUT AND OUTPUT CABLE OF THE UPS IS REQUIRED TO BE LESS THAN 5%.
- 

How to add a new UPS to a parallel system:

1. Firstly, a main maintenance mechanical switch or static switch should be installed in the parallel system.
2. Regulate the output voltage of the new UPS: check if the output voltage difference between the new UPS and the parallel system is less than 0.5 V.
3. Ensure the bypass of the parallel system is normal and the auto bypass setting is at “enable,” then press the button to turn off the UPS, the UPS will switch to bypass mode.
4. Set the main maintenance switch or static switch from “UPS” to “BPS,” then switch off the main output breaker, input breaker and mains breaker. The UPS will then shut down.
5. Connect the cable and wire for the new UPS.
6. Switch on the input breakers and mains breaker and make sure that every UPS is in bypass mode.
7. Switch on the output breakers and main output breaker, transfer the main maintenance switch or static switch from “BPS” to “UPS”.
8. Press the button on one UPS - all the UPSs will turn on. The system will work in line mode.

How to remove a single UPS from a parallel system:

1. Firstly, a main maintenance mechanical switch or static switch should be installed on the parallel system.
2. Ensure the bypass is normal and the auto bypass setting is at “enable,” then press the button to turn off the UPS system and the UPS system will switch to bypass mode.
3. Transfer the main maintenance switch or static switch from “UPS” to “BPS,” then switch off the output breakers, input breakers and mains breaker in the parallel system. The UPS will then shut down.
4. Switch off the main output breaker and output breaker in the parallel system.
5. Remove the UPS of interest and disconnect cables/wires.
6. Switch on the mains breaker and input breaker of the reserve UPS, make sure the UPS is in bypass mode.
7. Switch on the output breaker and main output breaker.
8. Transfer the main maintenance switch or static switch from “BPS” to “UPS” and press the button to turn on the UPS, and the UPS will turn on in line mode.

How to remove all the UPSs from a parallel system:

1. Firstly, a main maintenance mechanical switch or static switch should be installed on the parallel system.
2. Ensure the bypass is normal and the auto bypass setting is set to “enable”. Press the button to turn off the UPS system, and the UPS system will switch to bypass mode.
3. Transfer the main maintenance switch or static switch from “UPS” to “BPS”, then switch off the output breakers, input breakers and mains breaker in the parallel system, and the UPS will shut down. The line will power the load via the maintenance mechanical switch or static switch.

# 4 Operation

This chapter describes how the UPS is operated through the LCD.

The user can:

- Operate the LCD
- Start up and shut down the UPS (excluding the commissioning start up)
- Operate additional SNMP adapters and their software

## 4.1 Control panel

20 Control panel

The user-friendly control panel has two parts:

- Selection keys
- Power management LCD (PMD)
- Status LEDs

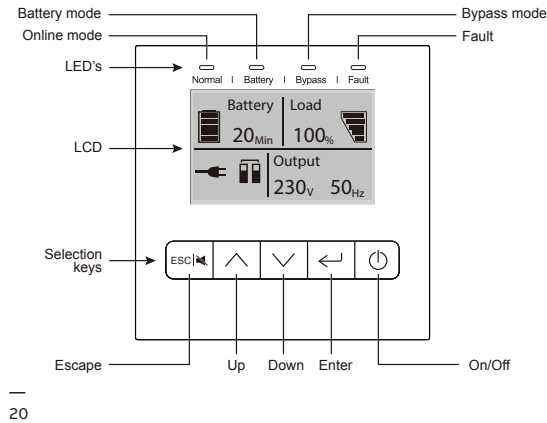

### 4.1.1 Selection keys

Table 5: UPS selection keys

Button	Function	Illustration
	Power ON/OFF	Turn the UPS on and off or change operating mode.
	Scroll UP	Scroll up through the menu.
	Scroll DOWN	Scroll down through the menu.
	Select / Edit	Select and confirm settings.
	Exit / Mute	Exit menus and mute the buzzer.

### 4.1.2 LED's status indicators

Table 6: UPS selection keys

Indicator	Status	Description
<b>NORMAL (GREEN)</b>	ON	The UPS is operating normally on online or on high efficiency mode.
<b>BATTERY (ORANGE)</b>	ON	The UPS is in battery mode.
<b>BYPASS (ORANGE)</b>	ON	The UPS is in bypass mode.
	Flash	The UPS is in standby mode.
<b>FAULT (RED)</b>	ON	The UPS has an active alarm or fault.

21 The default LCD

#### 4.1.3 LCD

The LCD shows an overview of the status of the UPS:

- Input
- Output
- Battery
- Load parameters
- Working mode
- Settings on voltage
- Frequency
- Bypass presence.

The LCD backlight automatically dims after two minutes of inactivity (except in cases of UPS fault). Press any button to wake up the screen.

A buzzer indicates UPS status. Table 7 lists the buzzer status meanings

**Table 7: Definition of alarms**

UPS condition	Buzzer status
Active fault	Continuous
Active warning	Beep every second
Battery	UPS on battery: Beep every 4 seconds Low battery: Buzzer beeps every second
Bypass	Beep every two minutes
Overload	Beep twice every second

When powering on, the LCD shows the UPS status. The UPS will also return to this default screen when no buttons have been pressed for 15 minutes.

The status screen shows the following information:

- Status summary, including operating mode and load information
- Alarm status, if present (including fault and warning information)
- Battery and charger status (including battery voltage, charge level and charger status)
- Current runtime information

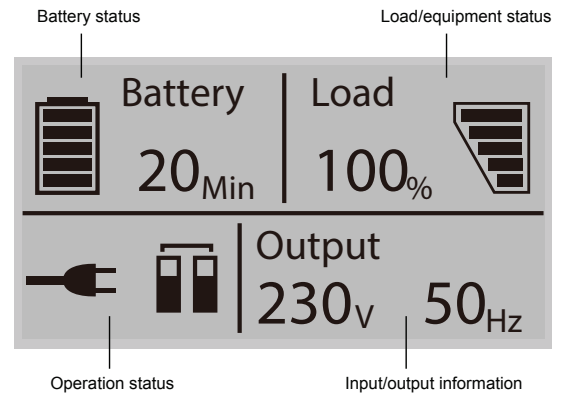













21

For more information on how to use the LCD, see Chapter 4.4 and 4.6.

## 4.2 Operating mode

The following table describes the UPS status information:

Table 8: Symbols in operating mode

Status	Symbol	Description
Online-mode		UPS is running through the inverter (online mode)
Battery-mode		UPS is running on battery. The alarm buzzer sounds every 4 seconds. Depending on the UPS load and number of extended battery modules (EBMs), the "Battery Low" warning may occur before the battery reaches 20 percent capacity. The alarm buzzer sounds every second
Bypass-mode		The power used by the load is supplied from the mains power via an internal filter. Note that if there is a power failure and the UPS is in bypass mode, it will not transfer back to mains or battery mode. In bypass mode, the alarm buzzer will sound every two minutes.
Bypass without output		UPS is running in bypass, but there is no power at the output.
ECO-mode (HE: high efficiency-mode)		After the UPS is turned on, the power used by the load is supplied from the mains (if its power is within an acceptable range) via an internal filter. This guarantees higher UPS efficiency. On mains failure, the UPS transfers to online mode or battery mode and the load is supplied continuously.  <b>Note:</b> ECO mode can be enabled through the LCD settings or the monitoring software. <b>Warning:</b> The transfer time of the UPS output from ECO mode to battery mode is 10 ms and is not recommended for sensitive loads.
Converter-mode		In converter mode, the UPS runs with fixed-output frequency (50 Hz or 60 Hz). On mains failure, the UPS transfers to battery mode and the load is supplied continuously.  <b>Note:</b> <ul style="list-style-type: none"> <li>• Converter mode function can be enabled through the LCD settings or the monitoring software.</li> <li>• The load is derated to 70 percent in converter mode.</li> </ul>
Warning		Warnings indicate abnormal situations that do not stop the UPS from working. The UPS continues running, but the user should perform corrective actions, see Chapter 6.
Fault		In case of failure, the UPS may disconnect the load or transfer to bypass depending on the cause of the failure. The UPS alarm sounds a continuous signal and the backlight of the UPS will turn red. For more information, see Chapter 6.
Overload		When the UPS is in overload, an alarm sounds twice every second. Disconnect unnecessary loads one by one to decrease the load. The load should be lower than 90 percent of its nominal power capacity in order to stop alarming.
Battery test		UPS is performing a battery test.
Battery disconnected		The battery is disconnected or defective. The UPS alarm sounds.
Parallel		The system is running in parallel.

## 4.3 UPS start-up and shutdown



WARNING

SWITCH OFF THE CONNECTED LOADS BEFORE TURNING ON THE UPS. SWITCH ON THE LOADS ONE BY ONE AFTER THE UPS IS TURNED ON. SWITCH OFF ALL OF THE CONNECTED LOADS BEFORE TURNING OFF THE UPS.



NOTE

THE FIRST TIME THE UPS IS STARTED UP, IT MUST BE CONNECTED TO THE UTILITY.

### 4.3.1 UPS start-up

To start up the UPS with mains supply:

1. Check that all cables are securely and correctly connected.
2. Keep the power button pressed for longer than 1 second. The fans will activate and the UPS will load for a few seconds.
3. The UPS will perform a self-test and the LCD will show the default UPS status screen.



NOTE

BYPASS MODE IS ENABLED BY DEFAULT AND CAN BE CONFIGURED THROUGH THE USER'S SETTINGS (FOR MORE INFORMATION, SEE TABLE 10).

To start up the UPS without mains supply (cold start):

4. Check that all cables are securely and correctly connected.
5. Keep the power button pressed for longer than 1 second. The UPS will power on, the fans will activate and the LCD will turn on. The UPS will perform a self-test and show the default UPS status screen.
6. Keep the power button pressed for longer than 1 second. The alarm buzzer will sound for 1 second and the UPS will start up.
7. After a few seconds, the UPS transfers to battery mode. When the UPS is supplied with power from the mains, the UPS transfers to online mode without interrupting the UPS power output.

### 4.3.2 UPS shutdown

To shut down the UPS with mains supply:

1. If the UPS is working in bypass mode, go to step 3.
2. If the UPS is in online mode, keep the power button pressed for more than 3 seconds. The alarm buzzer will sound and the UPS will transfer to bypass mode.



DANGER

THE OUTPUT IS STILL ENERGIZED.

3. Disconnect the mains power supply. The display will shut down and the output voltage will be removed from the UPS output terminal.
4. If the bypass has been disabled via the Settings menu, keep the power button pressed for longer than 3 seconds to shut down the UPS. The unit will transfer from online to standby mode. Disconnect the input power cable and the display will shut down.

To shut down the UPS without mains supply:

1. To power off the UPS, keep the power on/off button pressed for more than 3 seconds. The alarm buzzer will sound for 3 seconds and the output power will be immediately cut off.
2. The display will shut down and the output voltage will be removed from the UPS output terminal.

## 4.4 Display functions

Use the two middle buttons (⏪ and ⏩) to navigate the menu. Press the Enter (↵) button to select an option. Press the ESC button to cancel or return to the previous menu.

When the UPS starts up, the display is in the default UPS status summary screen.

Table 9: Display functions

Main menu	Submenu	Display information or menu function
UPS status		[Status summary screen] [Alarm] [Battery charging / Volt / level / remaining time] [Mode / Para Num. / Running time]
		[Load] W VA [Output / Current] A % [Output / Voltage] V Hz [Input / Voltage] V Hz [Battery] V % [DC bus] V V [Temperature] °C [Battery remaining time] Min
Measurements	Single UPS battery test	Starts a manual battery test for single UPS
	Parallel UPS battery test	Starts a manual battery test for parallel UPS
Control	Single UPS turn off	Turn off one UPS in parallel UPS system
	Reset fault status	Clears active fault
	Clear event log	Clears events
	Restore factory set	Returns all settings to original values
Settings		Sets parameters
Event log		Event list
Identification		[Product type/model] [Part / Serial number] [UPS / NMC firmware]



## 4.5 User settings

The following table displays the options that can be changed by the user.

Table 10: User settings

Submenu	Available settings	Default settings
<b>Password</b>	Key the password	USER
<b>Language</b>	[English][Deutsch][Español]	English
<b>User password</b>	[disabled] [Enabled]	[disabled]
<b>Audible alarm</b>	[enabled] [disabled]	[enabled]
<b>Output voltage</b>	[208V] [220V] [230V] [240V] Can be changed in standby mode and bypass mode	[230V]
<b>Output frequency</b>	[autosensing] [50HZ][60HZ]	[autosensing]
<b>Power strategy</b>	[normal] [high efficiency] [converter]	[normal]
<b>Auto bypass</b>	[enabled] [disabled]	[enabled]
<b>Auto restart</b>	[enabled] [disabled] Authorize the product to restart automatically when mains recovers after a complete battery discharge.	[enabled]
<b>Dry in</b>	[Disabled] [SON] [SOFF] [Maintain bypass]	[Disabled]
<b>Dry out</b>	[Load powered] [On battery mode] [Battery low] [Battery disconnected] [Bypass output] [UPS normal]	[Load powered]
<b>Start on battery</b>	[enabled] [disabled]	[enabled]
<b>External battery modules</b>	[0~20]	According to model
<b>External battery AH setting</b>	[0~300]	According to model
<b>Battery remaining time</b>	[enabled] [disabled]	[enabled]
<b>Charger current</b>	[0~4] 0~4A for standard model [0~12] 0~12A for long backup model	[4A] for 6-10 kVA
<b>Site wiring fault alarm</b>	[disabled] [enabled]	[disabled]
<b>LCD contrast</b>	[-5 ~ +5]	[+0]

# 4.6 LCD operation

- 22 Main menu
- 23 UPS status menu

In addition to the default UPS status summary screen, the user has access to useful information about the UPS status, including various detailed measurements, previous event records and the UPS identification. The settings can be changed to optimize the UPS for and by the user.

### 4.6.1 Main menu

In the default UPS status summary screen, when pressing **▲** or **▼** for more than 3 seconds, detailed information about alarm, battery or system status is displayed. In the default UPS status summary screen, press **ESC** for more than 3 seconds to return to the main menu tree. The main menu tree has six branches: UPS status menu, Measurement menu, Event log menu, Control menu, Identification menu and Settings menu.

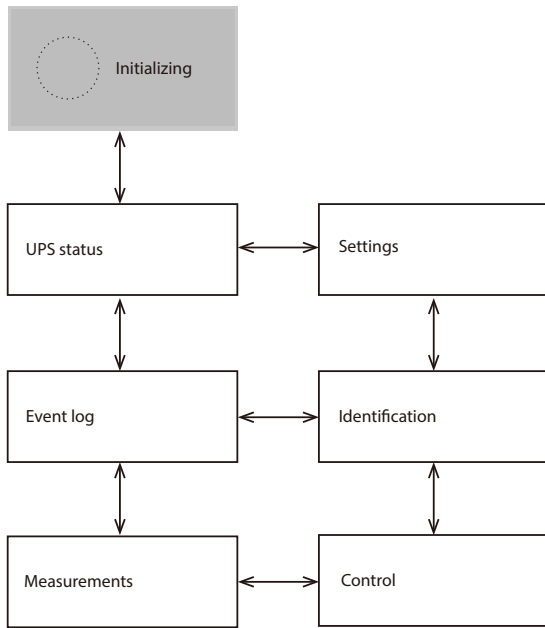

### 4.6.2 UPS status menu

By pressing **◀** on the UPS status menu, the next UPS status menu tree is displayed. The content of UPS status menu tree is same as the default UPS status summary menu. By pressing **ESC** for more than 3 seconds, the last main menu tree is displayed.

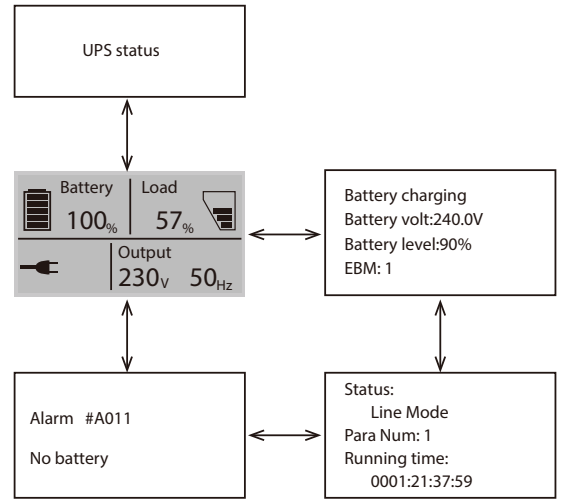



- 24 Measurement menu
- 25 Event log menu

**4.6.3 Measurement menu**

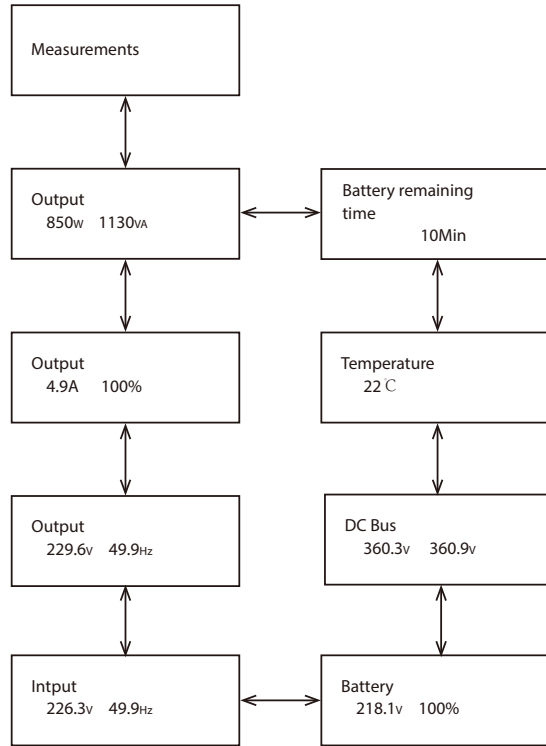
By pressing  on the Measurement menu, the next measurement menu tree is displayed. Detailed, useful information such as the output voltage and frequency, the output current, the load capacity, the input voltage and frequency, etc. can be accessed here. Pressing ESC for more than 3 seconds, returns to the last main menu tree.



**4.6.4 Event log menu**

By pressing  on the Event log menu, the next event menu tree is displayed. All previous events, alarms and faults are recorded here. Data includes the explanation, the event code, and the precise time in the UPS when the event happened. Pressing  or  for less than 3 seconds, scrolls through events one by one. The maximum number of recorded events is 100. If this limit is exceeded, the latest event will replace the oldest. Pressing ESC for more than 3 seconds displays the last main menu tree.

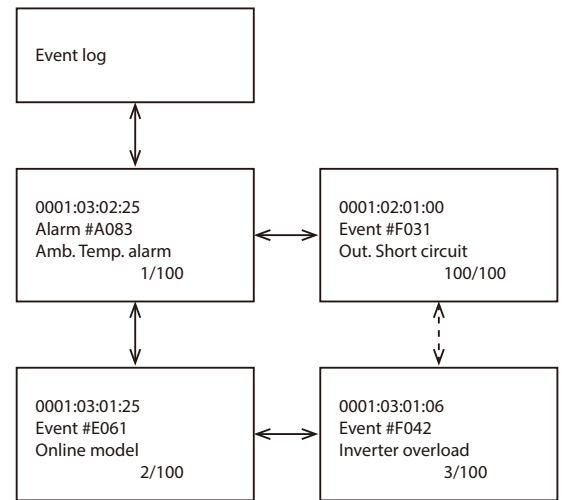

- 26 Control menu
- 27 Identification menu

### 4.6.5 Control menu

By pressing **↩** on the Control menu, the next control menu tree is displayed.

**Start Battery Test:** this is the command that allows the UPS to do a battery test.

**Reset Fault status:** when a fault occurs, the UPS will stay in Fault mode and the alarm will continue to ring. Enter this menu to reset error status: then the UPS stops the alarm and recovers to bypass mode. The cause of the fault should be checked and corrected before the UPS is reset manually.

**Restore factory settings:** all the settings are reset to default factory settings. Can only be done in bypass mode.

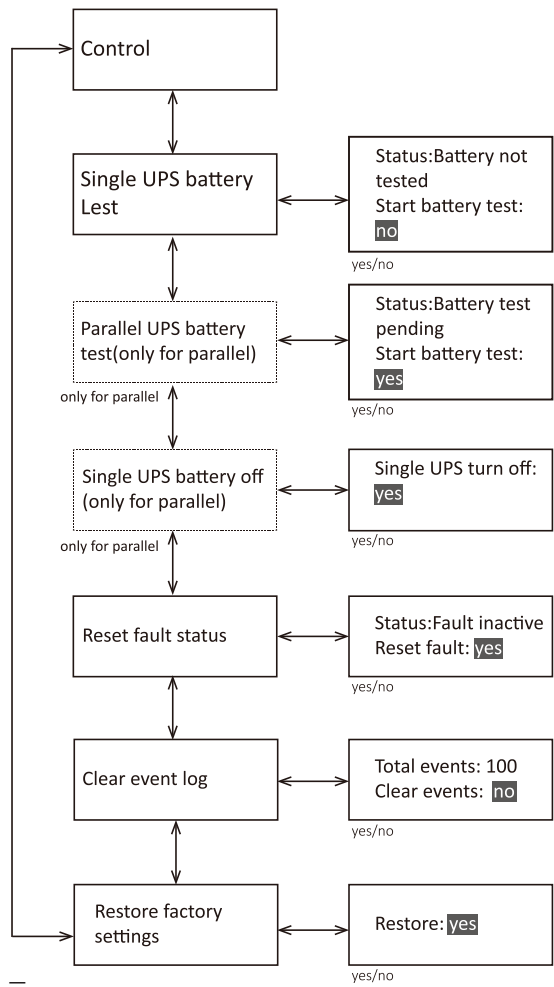

### 4.6.6 Identification menu

By pressing **↩** on the Identification menu, the next identification menu tree is displayed.

Identification information includes UPS serial number, firmware serial number and model type.

Press ESC for more than 3 s to return to the last main menu tree.

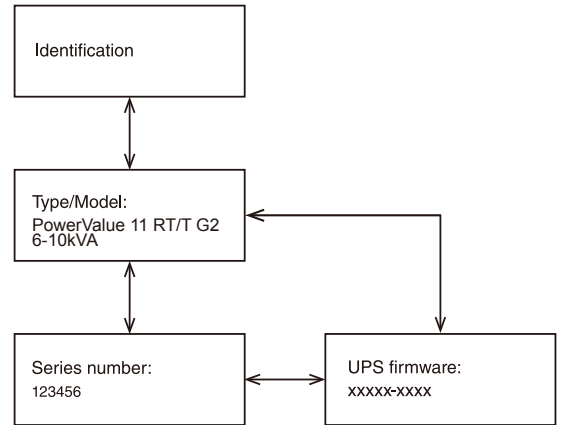

- 28 Setting menu
- 29 Example (set-up)

### 4.6.7 Setting menu



PLEASE CONTACT YOUR LOCAL DISTRIBUTOR FOR FURTHER INFORMATION BEFORE CHANGING SETTINGS. SOME SETTINGS CHANGE THE SPECIFICATION OF THE UPS AND SOME SETTINGS ENABLE OR DISABLE SOME IMPORTANT FUNCTIONS. UNSUITABLE SETTINGS ENTERED BY A USER MAY RESULT IN POTENTIAL FAILURES OR PROTECTION FUNCTION LOSS, OR EVEN DIRECTLY DAMAGE THE LOAD, BATTERY OR UPS.



MOST SETTINGS CAN ONLY BE CHANGED WHILE THE UPS IS IN BYPASS MODE

### Example: set rated output voltage value.

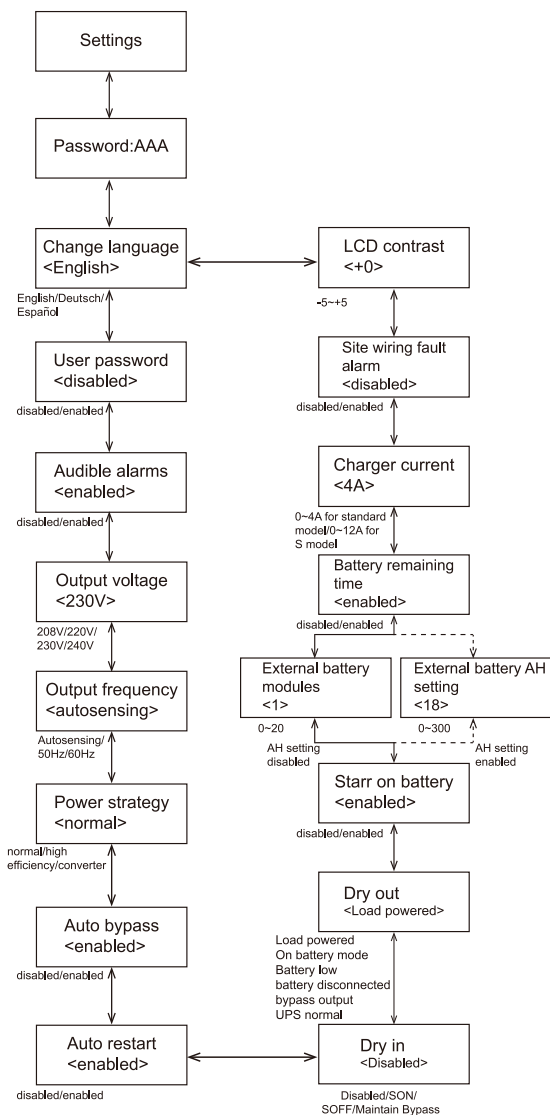
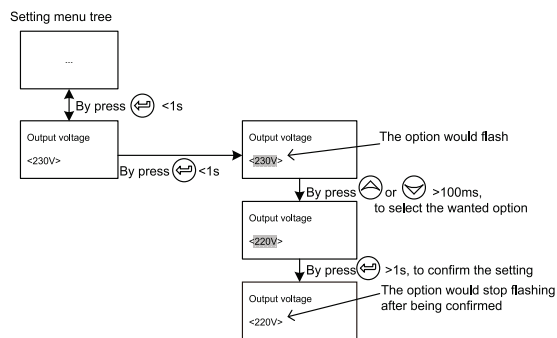

# 5 Communication

A USB and an RS-232 port are available to enable the communication between the UPS and a remote computer/ station. Only one communication port can be active at a time and the priority is given to the USB port.

Once the communication cable is installed, the power management software can exchange information with the UPS. The software collects information from the UPS and indicates the status of the device, the power quality of the mains and the battery autonomy of the units.

If there is a power failure and a predicted shutdown of the UPS due to low battery autonomies, the monitoring system can save the load data and initiate shutdown of the equipment connected to the UPS.

## 5.1 RS-232 port

30 RS-232 Communication Port (DB-9 Connector)

The UPS has an RS-232 port for UPS monitoring, control and firmware updates. To establish communication between the UPS and a computer, connect one end of the serial communication cable to the RS-232 port on the UPS and the other end to the RS-232 port of a computer.

The cable pins for the RS-232 communication port are described in “Figure 30” and “Table 11”.

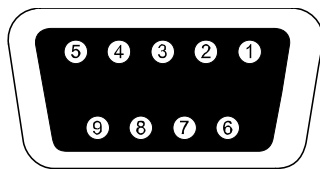

30

Table 11: Communication port pin assignment

PIN	Signal Name	Function	Direction from UPS
1	DCD	Battery low signal	Out
2	TxD	Transmit to external device	Out
3	RxD	Receive from external device	In
4	DTR	PnP from external device	In
5	GND	Signal common	--
6	DSR	To external device	Out
7	RTS	No connection	In
8	CTS	On battery signal	Out
9	RI	V <sub>DC</sub> power	Out

## 5.2 USB port

The UPS can communicate with USB-compliant computers that run power management software. To establish communication between the UPS and a computer, connect the USB cable to the USB port on the UPS. Connect the other end of the cable to the USB port on a computer.

## 5.3 Emergency power off

—  
31 EPO (Emergency power off)  
—  
32 Dry IN & OUT connector

The EPO connector can be used to block the output of the UPS in case of an emergency. The EPO connector can be configured as Normally Closed (NC) or Normally Opened (NO) through the USB or RS232 port.

By default, the EPO connector is Normally Closed (NC) by a jumper in the rear panel. If the jumper is removed, the UPS output will not supply energy to the load until the EPO status is changed. To return to normal status, the EPO connector must be closed. Enter the LCD menu to clear the EPO status (Control-->Reset fault status-->Reset fault). The UPS alarm is cleared and bypass mode is recovered. Set the UPS to inverter mode manually.

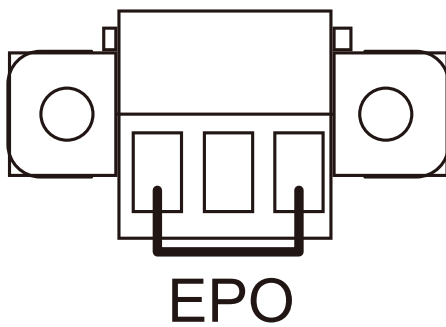

—  
31

### 5.3.1 Dry IN

Dry in allows a remote action to switch on/ switch off/ maintenance bypass the UPS.

This is done by switching the contact from closed to open.

### 5.3.2 Dry OUT

The dry out port is normally closed. If the dry out port is open, it indicates that the UPS is running in bypass or inverter mode / on battery mode / battery low / battery disconnected / bypass output/ UPS normal.

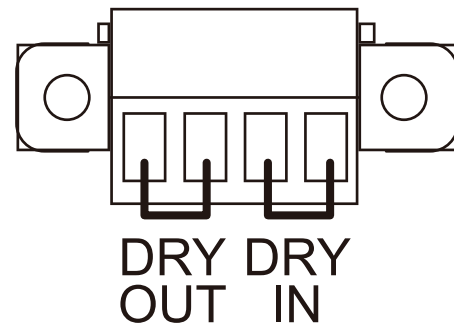

—  
32

## 5.4 Network management card (optional)

The PowerValue 11 RT G2 6–10 kVA is equipped with an intelligent slot for optional cards for remote management of the UPS through the Internet/intranet. Either of the following accessories can be installed in the intelligent slot:

- **SNMP/Modbus Card** – SNMP/Modbus, HTTP and monitoring capabilities through a Web browser interface.
- **AS400 Card** – AS400 card for AS400 communication protocol.

### 5.4.1 Installing a serial network management card (optional)

Each UPS has a communication slot for an optional serial network management protocol (SNMP/Modbus) card. After installing an SNMP/Modbus card, an environmental monitoring probe can be connected.



THE UPS DOES NOT HAVE TO BE SHUT DOWN BEFORE INSTALLING A COMMUNICATION CARD.

To install a network management card:

1. Remove the two screws that protect the communication slot of the UPS.
  2. Insert the SNMP/Modbus card into the communication slot.
  3. Screw the SNMP/Modbus card onto the slot using the screws removed in Step 1
- Compatible SNMP/Modbus cards: CS141 Basic, CS141 ModBus, CS141 Advanced, Winpower SNMP, Winpower ModBus.

For more information on the SNMP/Modbus Cards, see the SNMP/Modbus user's manual. For more details about parameters available when using an SNMP/Modbus card with PowerValue 11 RT G2, see Appendices A and B.

### 5.4.2 Monitoring software

The UPS can be monitored using software. The software provides a remote and safe shutdown for multi-client systems in case of absence of power at the UPS output. Instructions on how to install the software are provided with the network management cards.

For more information, contact your local supplier.



# 6 Troubleshooting

## 6.1 Fault identification and rectification

Alarms and events indicate warnings and notify of errors or potential failures in the system. The output of the UPS is not necessarily affected when an alarm arises but taking the correct actions may prevent loss of power to the load.

## 6.2 Accessing alarms

The control panel provides troubleshooting information from two main menus:



- UPS status menu: access to all active alarms
- Event log menu: access to the most recent 50 events, which may include active and closed alarms.



### UPS status menu

From the UPS status menu, you can access the following screens for troubleshooting information:

- **Status summary:** The status summary screen provides information on both operating mode and load. During normal operation, the display has a blue background with white text. In the case of a critical alarm, the backlight color changes to orange with dark text.
- **Alarm:** A separate screen appears for each active notice or alarm.
- **Battery status:** The battery status screen indicates the battery charge mode, the percentage of the battery that is charged and runtime with the present load.

To access troubleshooting information using the UPS status menu screen:

1. Press  for longer than 1 second to go to the UPS status menu screen.
2. Press  to access the UPS status main screen.
3. Press  to access the notice and alarm screens.
4. The UPS status main screen shows load information. The status icon indicates the UPS operating-mode.





5. Press  to scroll through the notice and alarm information.
6. After scrolling through all alarms, press  to access the battery status screen.

### Event log menu

From the Event log menu, you can access the latest 50 alarms, events and notices, arranged from newest to oldest. Events and alarms are logged in the Event log when they occur and, if applicable, when they are cleared:

- Events are silent conditions that are recorded in the Event log as status information. Events do not require a response.
- Alarms, including active alarms, are recorded in the Event log. Active alarms are announced by either an intermittent beep or a continuous sound. Examples are “Fan locked” and “Heat sink temperature high.” Active alarms require a response.

To access troubleshooting information using the Event log menu:

1. Press  for 1 second to go to the main menu selection and scroll down to the Event log menu using .
2. Press  to enter the Event log list.
3. Scroll through the listed events, notices, and alarms using  or .



NOTE

THE MOST RECENT EVENTS ARE DISPLAYED ON TOP OF THE LIST (FOR EXAMPLE 1/50).

Alarm or Event	Possible cause	Remedy
Battery mode Battery (Orange) LED is on. 1 beep every 4 seconds. Code: E062	A utility failure has occurred and the UPS is in battery mode.	The UPS is powering the equipment with battery power. Prepare your equipment for shutdown.
Battery low Battery (Orange) LED is on. 1 beep every 1 second. Code: A012	The UPS is in battery mode and the battery is running low.	This warning is approximate, and the actual time to shutdown may vary significantly. Depending on the UPS load and number of extended battery modules (EBMs), the "Battery Low" warning may occur before the batteries reach 20 percent capacity.
No battery Fault (Red) LED is Flash 1beep every 1 second Code: A011	The batteries are disconnected.	Verify that all batteries are properly connected. If the condition persists, contact your service representative.
Bypass mode Bypass (Orange) LED is on. Code: E060	An overload or a fault has occurred, or a command has been received and the UPS is in bypass mode.	Equipment is powered but not protected by the UPS. Check for one of the following alarms: over temperature, overload or UPS failure.
Power overload Fault (Red) LED is Flash 2 beeps every 1 second Code: A041	Power requirements exceed the UPS capacity.	Remove some of the equipment from the UPS. The UPS continues to operate, but may switch to bypass mode or shut down if the load increases. The alarm resets when the condition becomes inactive.
UPS over temperature Fault (Red) LED is on. Beep continuous. Code: F081	The UPS internal heat sink temperature is too high, or a fan has failed. At the warning level, the UPS generates the alarm but remains in the current operating state. If the temperature rises another 2°C, the UPS transfers to bypass mode or standby mode.	Clear vents and remove any heat sources. Allow the UPS to cool. Ensure the airflow around the UPS is not restricted. Restart the UPS. If the condition persists, contact your service representative.
ON Maintenance Bypass Bypass (Orange) LED is on. Code: A072	UPS was manually commanded to switch to bypass and will remain in bypass until commanded out of bypass.	Check the maintenance bypass switch status.
In HE Mode Line (green) LED is on. Code: E063	The UPS is on bypass while operating on the high efficiency setting.	The equipment transferred to bypass utility power as a normal function of high efficiency operation. Battery mode is available and your equipment is protected.
Site Wiring Fault Fault (Red) LED is flash 1beep every 1 second Code: A004	Site fault detection is supported on all models any time there is a grounding neutral connection. Alarm triggers when the difference between ground and neutral voltage is >15 V.	Site fault detection should be enabled by default. It can still be enabled / disabled from the LCD settings menu. Reconnect all input wires.
Back feed Fault (Red) LED is On. Beep continuous. Code: F093	UPS has an unexpected bypass current on battery mode.	Transfer to maintenance bypass and call service.
Inv Overload Fault Fault (Red) LED is On. Beep continuous. Code: F042	UPS has transferred to bypass or fault mode because of overload in inverter mode.	The UPS transfers to battery mode if supporting the load. Remove some of the equipment from the UPS.
Byp Overload Fault Fault (Red) LED is On. Beep continuous. Code: F043	UPS has cut off the output and transferred to fault mode because of overload in bypass mode or HE mode.	Remove some of the equipment from the UPS.
Output Short Circuit Fault (Red) LED is On. Beep continuous. Code: F031	Indicates that the UPS has detected abnormally low impedance placed on its output and considers it a short circuit.	Remove all the loads. Turn off the UPS. Check if UPS output and load has short circuit. Ensure short circuit is removed before turning on again.
Fan Failure Fault (Red) LED is flash 1 beep every 1 second Code: A085	Indicates that the fan could not work normally. Check UPS fans.	
BUS Over Voltage Fault (Red) LED is On. Beep continuous. Code: F021	Indicates that the UPS has bus overvoltage fault.	The UPS transfers to bypass mode if supporting the load.

Alarm or Event	Possible cause	Remedy
BUS Under Voltage Fault (Red) LED is On. Beep continuous. Code: F022	Indicates that the UPS has bus undervoltage fault.	The UPS transfers to bypass mode if supporting the load.
BUS Unbalance Fault (Red) LED is On. Beep continuous. Code: F023	Indicates that the positive bus voltage and negative bus voltage are too lopsided.	The UPS transfers to bypass mode if supporting the load.
BUS Short Fault (Red) LED is On. Beep continuous. Code: F024	Indicates that the bus voltage is decreasing very fast.	Contact your service representative.
BUS Softstart Fail Fault (Red) LED is On. Beep continuous. Code: F025	Indicates that the bus could not soft start successfully.	Contact your service representative.
Inv Over Voltage Fault (Red) LED is On. Beep continuous. Code: F032	Indicates that the UPS has inverter overvoltage fault.	The UPS transfers to bypass mode if supporting the load.
Inv Under Voltage Fault (Red) LED is On. Beep continuous. Code: F033	Indicates that the UPS has inverter undervoltage fault.	The UPS transfers to bypass mode if supporting the load.
Inv Softstart Fail Fault (Red) LED is On. Beep continuous. Code: F034	Indicates that the inverter could not soft start successfully.	Contact your service representative.
Charger Fail Fault (Red) LED is flash 1 beep every 1 second Code: A015	Indicates that the UPS has confirmed the charger has failed.	The UPS turns off the charger until the next power recycle. Contact your service representative.
Battery Over Voltage Fault (Red) LED is On. Beep continuous. Code: F016	Indicates that the battery voltage is too high.	The UPS will turn off the charger until the battery voltage is normal.
Negative power Fault Fault (Red) LED is On. Beep continuous. Code: F0E1	In a parallel system, power of UPS is negative.	Redundancy mode, the fault UPS turn to fault mode without output Increase mode, UPS1& UPS2 turn to fault mode.
Parallel cable loss Fault (Red) LED is On. Beep continuous. Code: F0E2	In parallel system, parallel cable disconnected.	Disconnect parallel cable one turn to fault mode.
Parallel system battery status Fault (Red) LED is flash 1 beep every 1 second Code: A0E6	UPS1 connect battery, UPS2 without battery.	Check battery connect status.
Line input different Fault (Red) LED is flash 1 beep every 1 second Code: A0E7	Parallel system, UPS1 line ok, UPS2 line loss.	Check the line input.
Power strategy different Fault (Red) LED is flash 1 beep every 1 second Code: A0E9	Parallel system, UPS mode (normal, converter, HE) different.	Check UPS OP mode, keep OP mode be the same.
Rate power different Fault (Red) LED is flash 1 beep every 1 second Code: A0EA	Parallel system rated power different.	Rated power different, not allowed to turn on UPS. Keep rated power the same.
HE in parallel Fault (Red) LED is flash 1 beep every 1 second Code: A0EB	Parallel system, UPS mode set as HE	HE not allowed in parallel system, change UPS mode.

Always have the following information available when calling the after-sales service department:

1. Model number and serial number
2. Date on which the problem occurred
3. LCD/LED display information and buzzer alarm status
4. Mains power condition, load type and capacity, environment temperature and ventilation condition
5. Information on external battery pack (battery capacity, quantity).

---

## 6.3 Silencing the alarm

Press the ESC (Escape) button on the front panel display for 3 seconds to silence the alarm. Check the alarm condition and perform the relevant action to resolve the condition. If the alarm status changes or the ESC button is pressed for 3 seconds again, the alarm beeps again, overriding the previous alarm silencing.

# Appendix A

## CS141 SNMP card available parameters (valid for CS141 Basic, CS141 ModBus, CS141 Advanced).

The parameters available for CS141 SNMP cards are shown below.

Parameter	Units	Type	Available interface	Modbus register
<b>Measurement Parameters</b>				
Input Voltage	V	Input	Webserver / Modbus	104
Input Frequency	Hz	Input	Webserver / Modbus	111
Output Voltage	V	Output	Webserver / Modbus	97
Output Load Percentage	%	Output	Webserver / Modbus	100
Battery Voltage	V	Battery	Webserver / Modbus	110
Battery Capacity	%	Battery	Webserver / Modbus	103
Temperature	°C	Environmental	Webserver / Modbus	107
<b>UPS Status Information</b>				
On shutdown			Webserver / Modbus	109
On inverter			Webserver / Modbus	109
On battery			Webserver / Modbus	109
<b>UPS Alarms</b>				
Battery Low			Webserver / Modbus	117
Input Bad			Webserver / Modbus	120
On Bypass			Webserver / Modbus	123
General Fault			Webserver / Modbus	132
Test In Progress			Webserver / Modbus	138
Shutdown imminent			Webserver / Modbus	137
Diagnose test failed			Webserver / Modbus	133

# Appendix B

## Winpower SNMP card available parameters (webserver interface)

The parameters available from WinPower SNMP cards are shown below.

Parameter	Type	View
UPS Status	General, status	UPS Monitoring >> UPS Status
UPS Temperature	General, measurement	UPS Monitoring >> UPS Status
Voltage	Input, measurement	UPS Monitoring >> UPS Status
Frequency	Input, measurement	UPS Monitoring >> UPS Status
Load (%)	Output, measurement	UPS Monitoring >> UPS Status
Voltage	Output, measurement	UPS Monitoring >> UPS Status
Frequency	Output, measurement	UPS Monitoring >> UPS Status
Battery Status	Battery, status	UPS Monitoring >> UPS Status
Capacity (%)	Battery, measurement	UPS Monitoring >> UPS Status
Voltage	Battery, measurement	UPS Monitoring >> UPS Status
Time on Battery	Battery, measurement	UPS Monitoring >> UPS Status
Output Rating Voltage	Output, Rating	UPS Monitoring >> UPS Parameters
Output Frequency Rating	Output, Rating	UPS Monitoring >> UPS Parameters
Output Rating VA	Output, Rating	UPS Monitoring >> UPS Parameters
UPS Model	Additional UPS Information	UPS Monitoring >> UPS Identification
UPS Description	Additional UPS Information	UPS Monitoring >> UPS Identification
Firmware Version	Additional Network card Information	UPS Monitoring >> UPS Identification
MAC Address	Additional Network card Information	UPS Monitoring >> UPS Identification





<https://library.abb.com>

—  
**ABB Switzerland Ltd.**

Via Luserte Sud 9  
CH-6572 Quartino  
Switzerland

**[abb.com/ups](https://abb.com/ups)**

